

CAN A PALLET CHANGE THE WORLD?

ONLY IF IT IS ENVIRONMENTALLY
FRIENDLY AND AWARD WINNER







IP GROUP

INTELLIGENT PACKAGING GROUP



MADE IN SWEDEN



Relationships create results. This is something we firmly believe in at IP-Group. As part of that philosophy we regard and value all our customers as partners. A close dialogue paves the way to joint success. Or as we usually say: If you win, we win.

As our company name suggests, we supply intelligent packaging. We develop, sell and rent out intelligent and cost-effective packaging systems in 100 per cent recyclable plastic and aluminium for companies in Europe (all over the world). We are a company with high ambitions, which essentially

means that an IP-Group product has to be flawless and delivered on time. Our products also optimise our customers' transports, reduce carbon emissions through the design together with our return system.

Sustainability plus concern about the environment and our customers' health and safety, set the standard when we develop new products. We are certified in compliance with ISO 9001:2008 and ISO 14001:2004.

[Find out more about our approach and product offering in the following pages.](#)

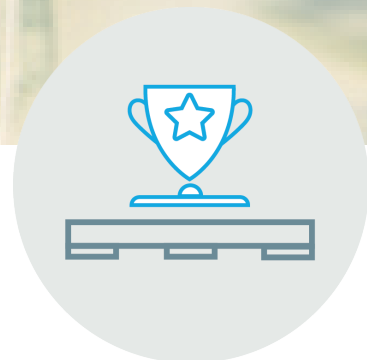

IP GROUP'S ENVIRONMENTAL PALLET **WORLD STAR WINNER**

IP Group's patent-pending Environmental Pallet has won the WorldStar prize for the world's best transport solution. The prize is awarded by the World Packaging Organisation (WPO).

WorldStar is the world's most prestigious packaging competition. The 54 international WorldStar winners meet in Sydney, Australia, to receive their awards.

The Environmental Pallet has also won the ScanStar award for the best Nordic transport solution.

Geir Vidar Persen, Sales Director IP-Group AS:

"The secret lies in the Environmental Pallet contributing to improved economy, better environment and better health and safety in the workplace. We are talking about 40 per cent fewer return shipments, at least 40 per cent better stackability, 40 per cent reduced weight, 40 per cent reduction in carbon emissions and 100 per cent recycling and reuse.



CONTENTS

WorldStar winner	4
More minimalism.....	5
Choose the Environmental Pallet	6
Winning concept	9
Many advantages	10
Effective return flows.....	13
Rental	14
Environmental Pallet 1208	15
Eco-pack	16
Environmental Pallet 6080	18
Environmental Pallet 6040	19
Save SEK 34 million.....	20
Closed-loop system.....	21
Lean & Green.....	22

MORE MINIMALISM TO THE TRANSPORT AND WAREHOUSING SECTOR!



For almost twenty years, IP Group has been helping you to reduce your transport costs through smart and eco-friendly packaging products. We strive as far as possible to develop and manufacture products from 100 per cent recyclable plastic. Our most popular product is the award-winning and patent-pending Environmental Pallet.

We offer both standard and fully customised solutions. A form of minimalism runs through our operations like a silver thread. We work hard to find solutions that save on costs, the environment and space.

CHOOSE THE ENVIRONMENTAL PALLET SAVE MONEY AND THE ENVIRONMENT.

The purchasing price for the Environmental Pallet may be high compared to a EUR wooden pallet. However, you get return on investment very quickly through reduced costs compared to wooden pallets and a saving of 40 per cent on your return transports.

» [Read more on page 10](#)

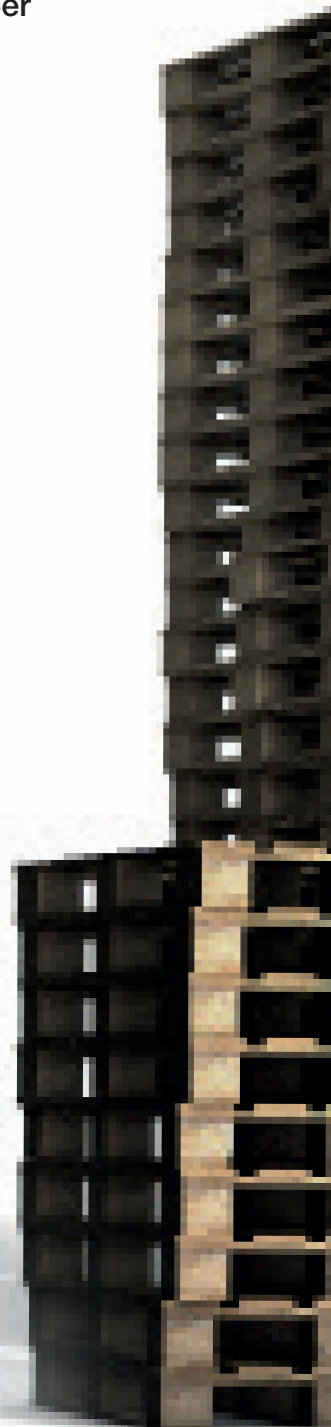



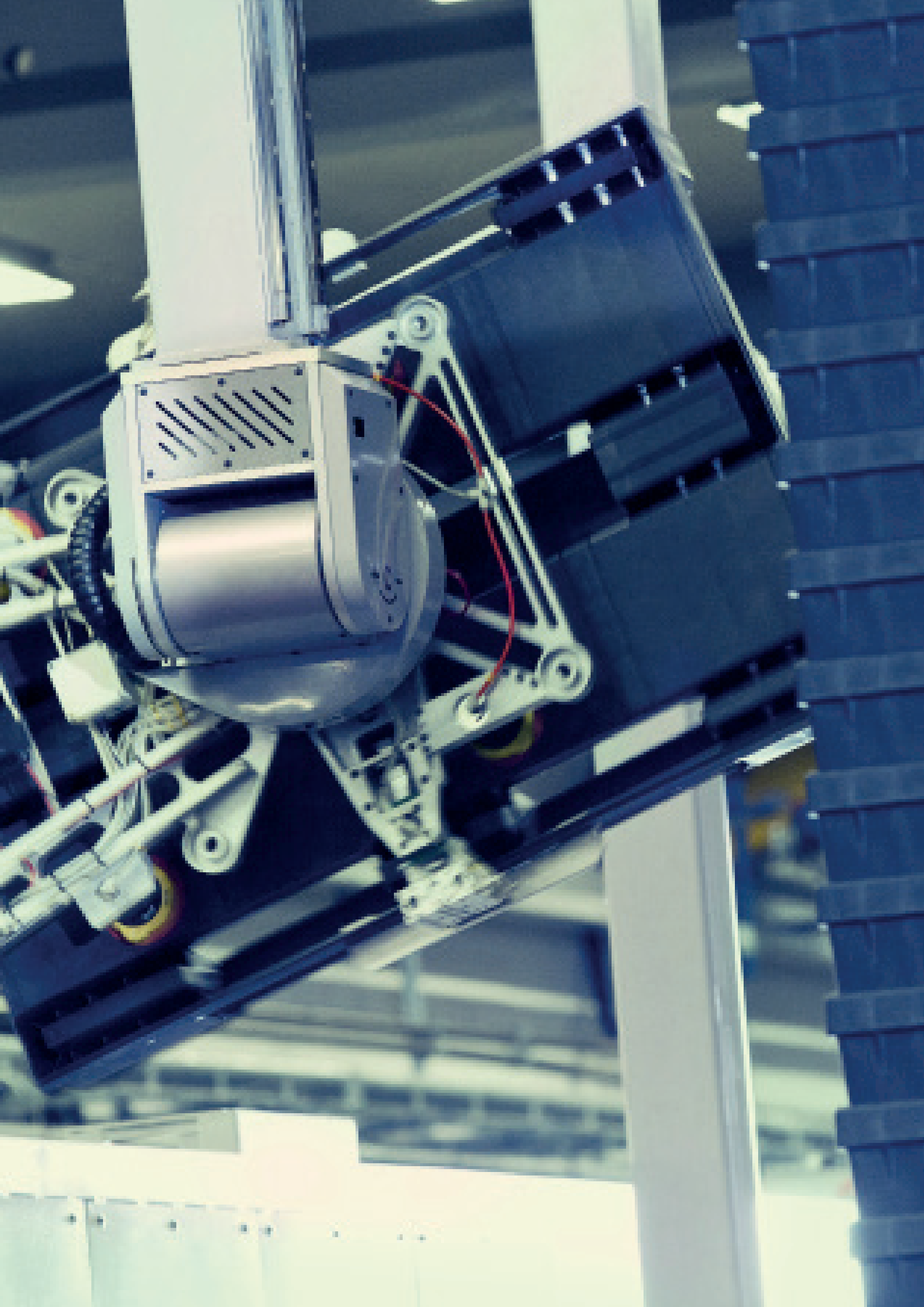

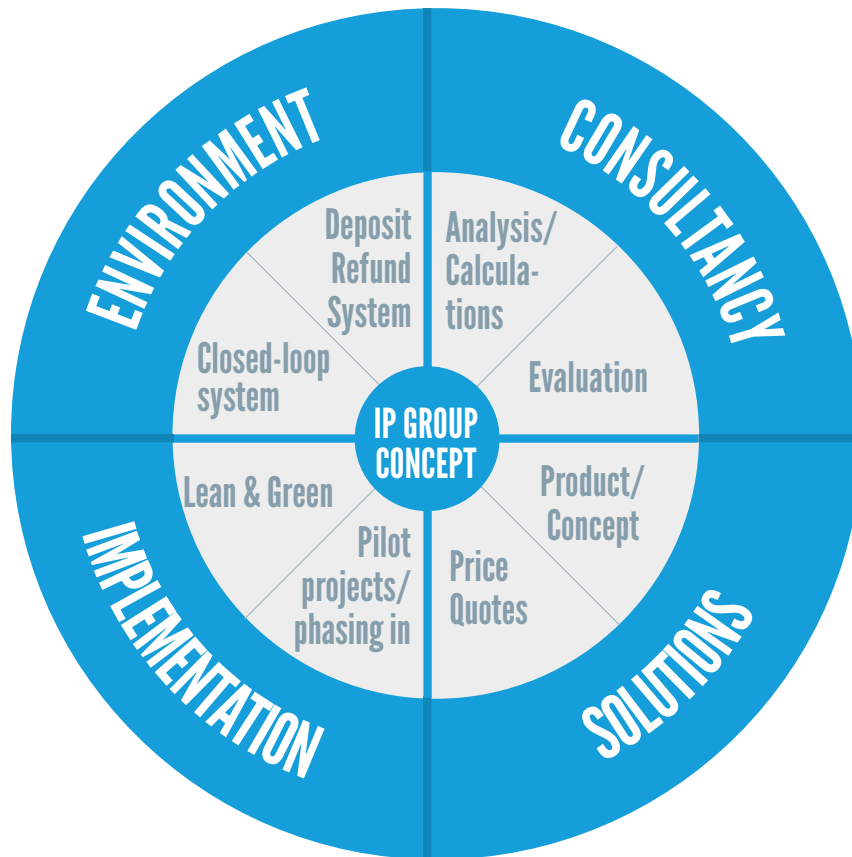

IP GROUP'S ENVIRONMENTAL PALLET A WINNING CONCEPT

Changing pallet systems is no small task. We are well aware of that. Which is why we have created the **IP Group Concept**. A turnkey solution that is implemented in your company's mode of operation and where we will train you in how to achieve greater efficiency, increased profitability and reduced costs.

The first step is **consultancy**. We conduct an analysis and provide you with an assessment of your needs.

Step two: Which is the most intelligent product concept for your company? Because we offer a turnkey solution

of pallets and eco-pack we will find a solution that works. **The solution is** presented together with a quote.

Step three: Once our quote is accepted, **implementation** is phased in along with our Lean & Green programme (read more about Lean & Green on page 22).

Good to know. Choose our Environmental Pallet and you choose a pallet that will make a difference. The Environmental Pallet is made from 100 per cent recyclable plastic, every bit of which is recycled when it reaches the end of its useful life, thus creating a green closed-loop system.

THE ENVIRONMENTAL PALLET

A PALLET THAT MAKES A DIFFERENCE!

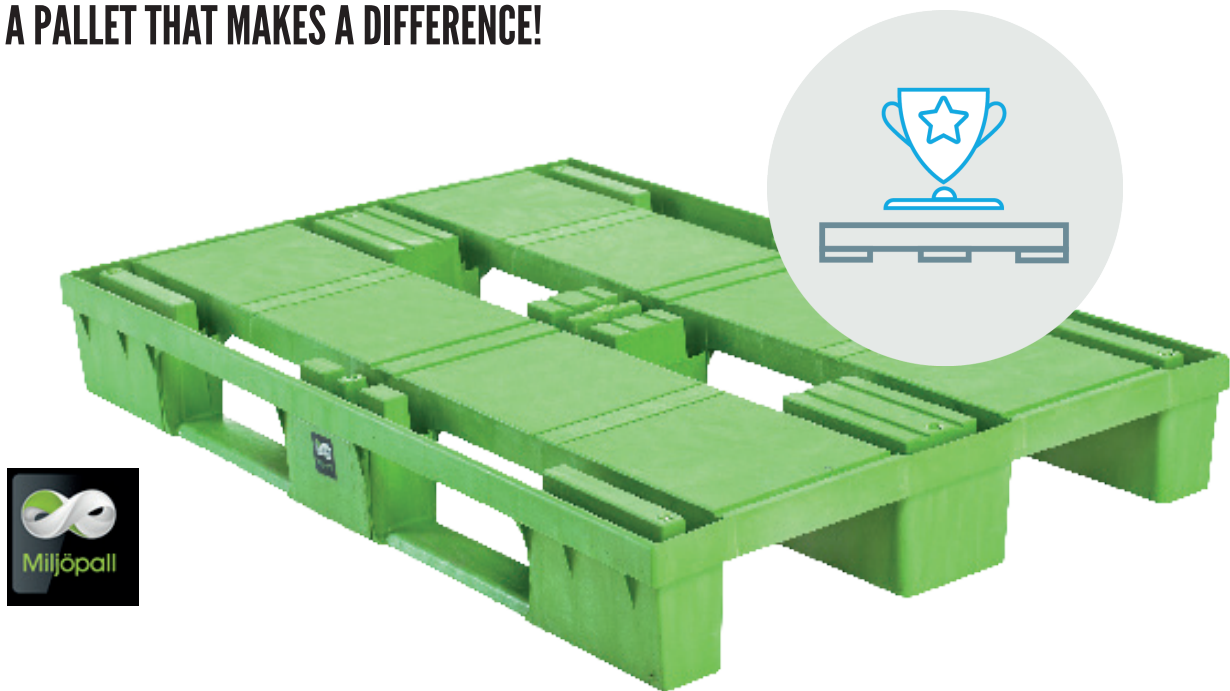

40%
FEWER
RETURN TRANSPORTS

40%
FEWER
CARBON EMISSIONS

40%
LOWER
WEIGHT

MANY ADVANTAGES

The Environmental Pallet did not come about by chance. It has taken a lot of hard work to design a pallet that actually makes a difference, not just for you who handle it, but also commercially and not least environmentally.

A new EUR wooden pallet costs around SEK 120. One of our corresponding Environmental Pallets costs more. Does it really pay? The answer is YES! That is the idea behind our concept. A win-win all round. You, us and our environment.

So, not only are the three pallet sizes based on EUR size 1200x800 mm compatible with each other like toy bricks, there are also great savings to be made. On several levels. In short, we are talking about 40 per cent fewer return shipments, at least 40 per cent reduced storage space, 40 per cent reduced weight, 40 per cent reduction in carbon emissions and 100 per cent recycling and reuse.

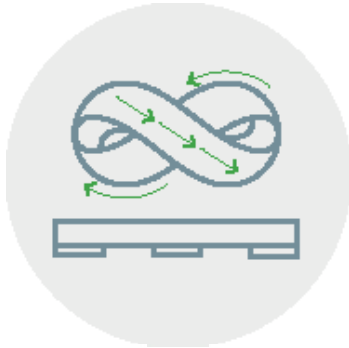

A closed-loop system with a deposit refund.

The Environmental Pallet is made from recycled plastic polypropylene (PP). It is 100 per cent recyclable with an expected life cycle of 6-10 years. The material can be recycled many times (into new eco pallets) until the quality no longer meets our high demands. The pallets are then ground down and reused in less quality demanding PP products. The pallets could also end their days by controlled incineration.

We pay a deposit refund for discarded or used Environmental Pallets (currently SEK 80 per pallet) and we grind down discarded pallets for recycling.



Space costs money.

This is why we are tight with our space.

The neat design of the Environmental Pallet enables you to stack 24 pallets per stack compared to 16 with the wooden pallet. Because you can load many more pallets, it reduces the number of lorries, the amount of storage space, the number of transports and your carbon emissions. By 40 per cent!

Stacked pallets are straight, stable and easy to handle. A truck's forks glide in smoothly (65mm space) to lift out the required number of pallets from a stack. Manual lifting is avoided and it creates a safer and healthier workplace.

ENVIRONMENTAL PALLET VS EUR WOODEN PALLET

WHAT MAKES THE ENVIRONMENTAL PALLET...

JUST AS GOOD

- Load
- Friction
- Dimension
- Distancing

BETTER

- Economy
- Weight
- Hygiene
- Work Environment
- Life Cycle
- Wastage
- Stacking Height
- Discards

UNIQUE

- Compatible
- Stackable
- Deposit Refund System
- Green



The environmental pallet saves 40 percent on your return flow!

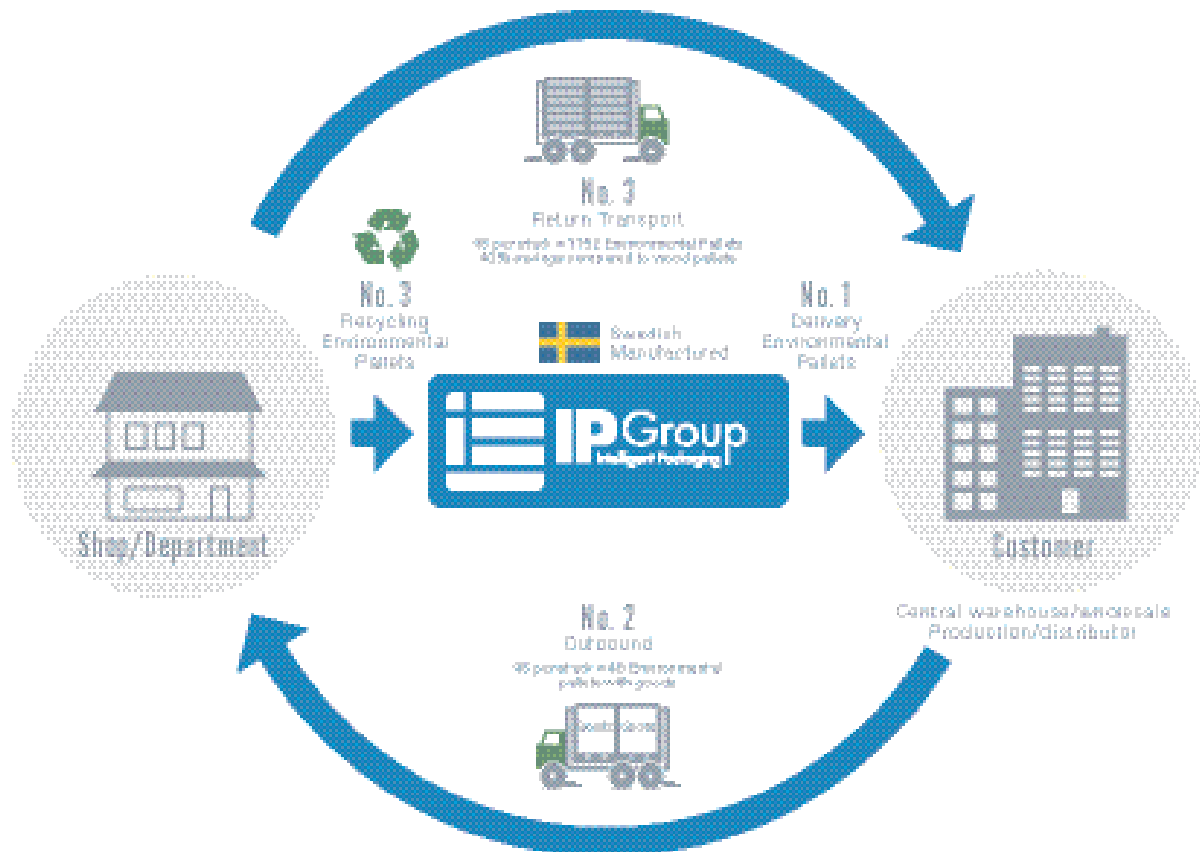

IP GROUP EFFECTIVE RETURN FLOWS

The Environmental Pallet is engineered to play its part in an effective return flow. The flow begins at **IP Group**. The straight recyclable pallet stacks leave the production point without wrapping or strapping. There is no risk of collapse. The pallet stacks take 40 per cent less space and facilitate double stacking. The pallets are distanced for easy unstacking and sit safe on the truck forks thanks to their friction material. In addition, the Environmental Pallet is 100 per cent recyclable and we give SEK 80 in deposit refund.

The Environmental Pallet **functions perfectly** in Production lines. Belt conveyors, chain conveyors and pallet racking systems pose no problems. A logo and RFID tags on the pallets reduces waste. Another positive aspect is that goods are not damaged by nails and splinters.

From production to **the Wholesaler**. Cartons and goods stand firm and safe on the pallets – the friction material is doing its job. The pallets manage 1000 kg in a pallet racking systems.

How the pallets reach the **Store**. The pallets are clean and neatly stacked, perfect for goods exposure in the store. The surface of the Environmental Pallet is hygienic and easy to hose down, and the low weight makes it easier to handle. Splinters, nails and wooden scraps all over the floor are things of the past.

Finally, as mentioned above, the company is a winner in effective return flows. 40 per cent fewer return transports and 40 per cent reduced weight equals 40 per cent reduced carbon emissions. A pallet that makes a difference!

RECYCLE - REUCE AND REDUCE

SUSTAINABLE DEVELOPMENT CIRCULAR ECONOMY

IP GROUP RENTAL

Would you like to avoid binding up capital and putting a strain on the company's cash flow? Then pallet rental could be the answer. Start saving now!

Renting has several advantages. You often avoid a drawn-out approval process for the investment and you do not need to bind capital and put a strain on the company's cash flow. You pay a monthly fee for the Environmental Pallet that is lower than for the wooden pallet. You also benefit from an immediate 40 per cent saving on return transports and storage, thus reducing the monthly costs even further.

This is how it works:

You decide to invest in the Environmental Pallet. A contract with the IP Group informs you of the terms and conditions. The normal rental period is between three and five years depending on your needs.

The fee can be fixed or flexible and with a rental agreement you can keep your payments within your budget.

ENVIRONMENTAL PALLET

FULL SIZE PALLET 1208

THE STRONGEST STACKABLE PALLET ON THE MARKET

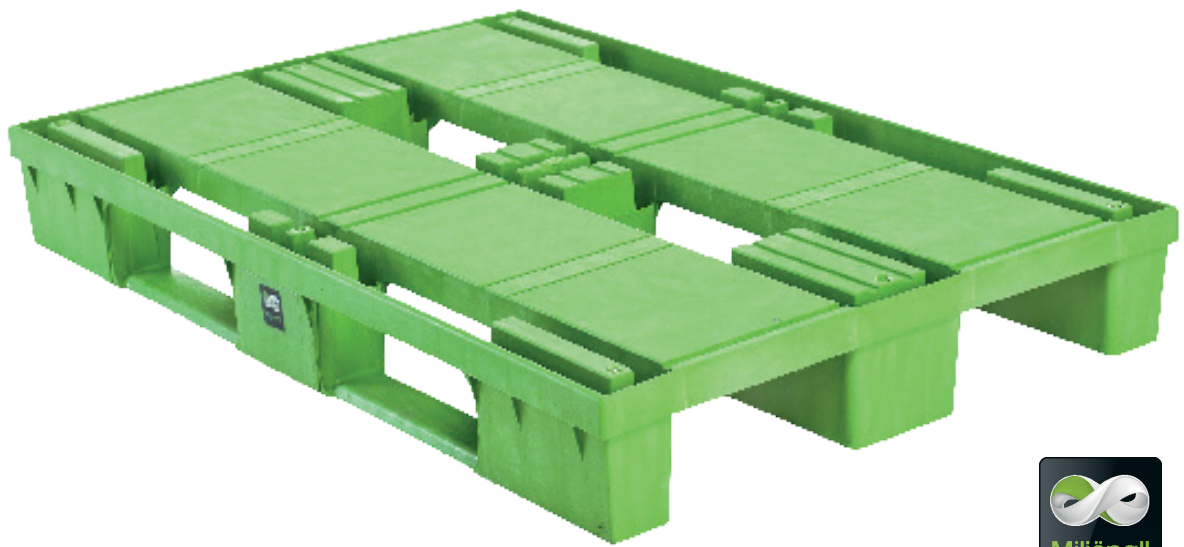

FACTS

Item:	IPG 1208
Dimensions:	1200 x 800 mm
Height:	150 mm
Weight:	16 kg
Load:	1000 kg dynamic
Material:	REPP
Logistics:	24 per stack

Suitable for:

Pallet Racking Systems
Belt Conveyors
Chain Conveyors
Wrapping

Suits crates with dimensions:

800x600 mm 400x300 mm
600x400 mm 300x200 mm



IP GROUP'S **ECOPACK**

RATIONALISES & PROTECTS

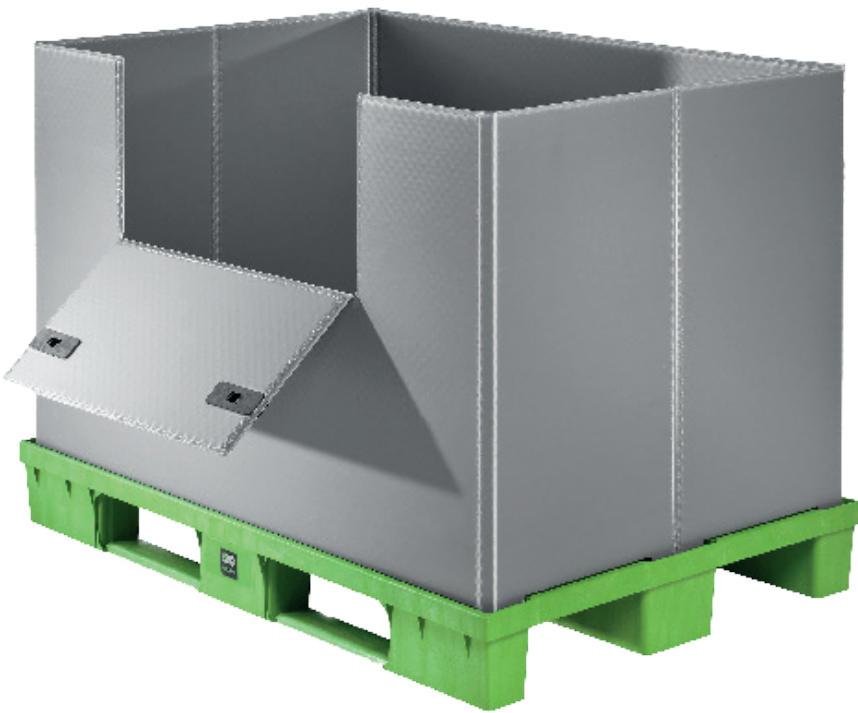

WHY ECOPACK?

- Rationalises outflows and returns
- Protects the products
- Stackable for transportation and storage
- In-store product exposure
- Possible to partition different products
- Avoid wrapping
- Replaces disposable packaging
- Reduces wasted resources

Ecopack's walls can be ordered in the exact height required. The standard colour is grey but other shades are available for larger volumes.

Design walls Ecopack:

Walls all round

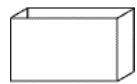

1X U-shaped
1X Straight wall

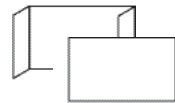

2x L-shaped walls

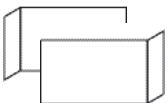

Options:

- Lid
- Hatch
- Deck plate
For a covered pallet deck without openings

Partition
Available 4-24 compartments



Logotype
RFID (id-chip)

WHEN 4 BECOMES 1

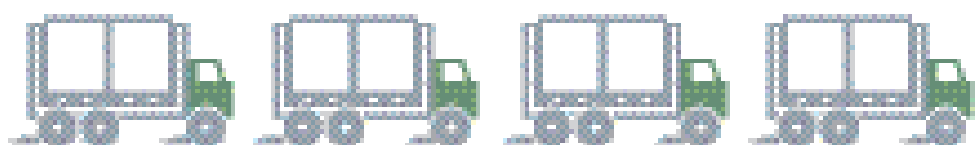

Ecopack with goods 1200x800x800 mm

Ecopack without goods 1200x800x180 mm

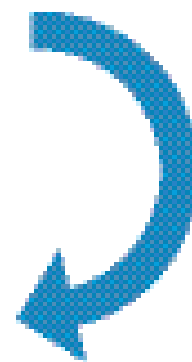
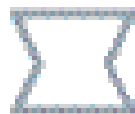
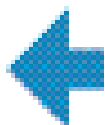
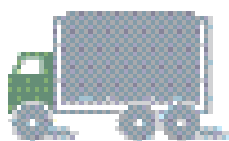

IP GROUP ECOPACK LOGISTIC SYSTEM

If you use the Environmental Pallet and build further with Ecopack, the system gets dimensions of 1200x800 mm in base and height according to your needs.

In return are the stackable Environmental Pallet, folded walls and lid. Each are returned on separate pallet spaces. The various product parts of the Environmental Pallet are separated upon return to give the most effective return flow possible.

An Environmental Pallet with dimensions 1200x800x800 mm with outgoing goods takes 1200x800x180 mm in return.

This means you can send out four lorries and get one back.

ENVIRONMENTAL PALLET

HALFPALLET 6080

STRONG & COMPATIBLE

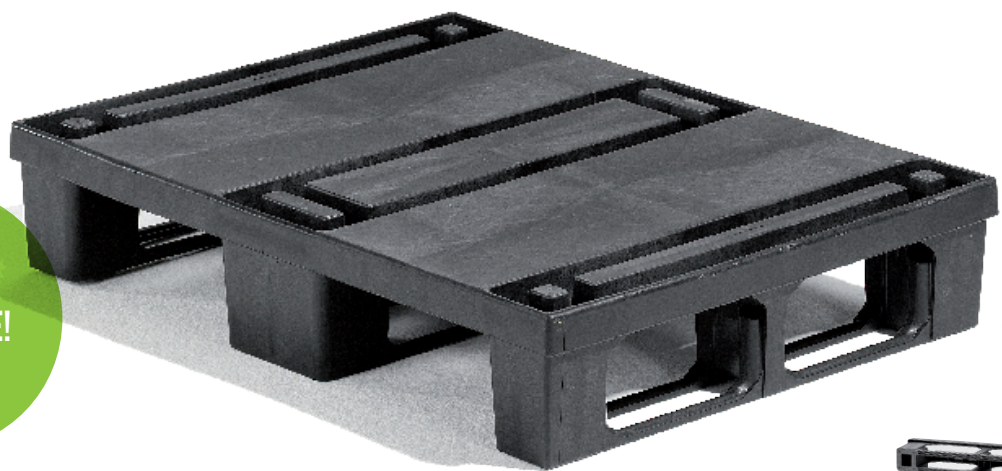

FACTS

Item: IPG 6080
Dimensions: 600 x 800 mm
Height: 150 mm
Weight: 7 kg
Load: 500 kg dynamic
Material: REPP
Logistics: 48 per stack

Suitable for:
Pallet Racking Systems
Belt Conveyors
Chain Conveyors

Suits crates with dimensions:
800x600 mm 400x300 mm
600x400 mm 300x200 mm



ENVIRONMENTAL PALLET

QUARTER PALLET 6040

STRONG & COMPATIBLE

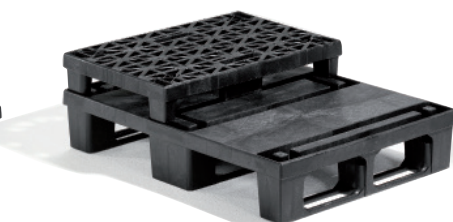
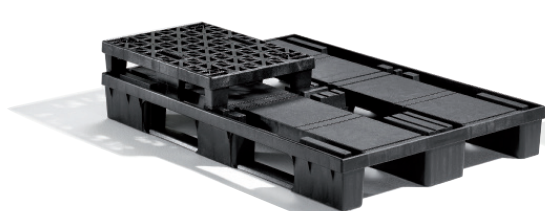
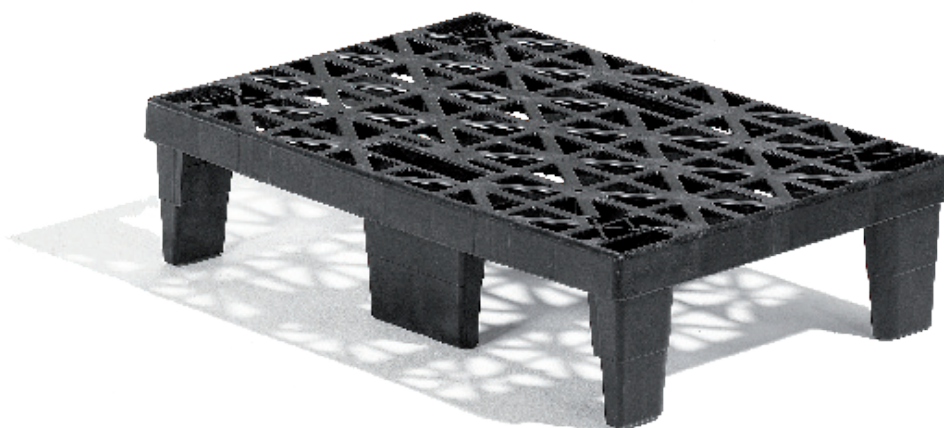

FACTS

Item: IPG 6040
Dimensions: 600 x 400 mm
Height: 150 mm
Weight: 2.4 kg
Load: 250 kg dynamic
Material: REPP
Logistics: 96 per stack

Compatible with
Environmental Pallet FULL SIZE PALLET 1208
Environmental Pallet HALF PALLET 6080

Suits crates with dimensions:
600x400 mm 300x200 mm
400x300 mm

Options
Locking of bottle packaging



COULD YOU ALSO SAVE SEK 34 MILLION IN TEN YEARS?

We help you to calculate your flow, contact us for a demonstration.

100 %
RESIRKULERBAR!



INVESTMENT IN IPG ENVIRONMENTAL PALLET VS EUR WOODEN PALLET

PALLET FLOW

	INFO
Number of dispatched pallets a day:	1,450
Current pallet spaces in return a year:	20,000
Proportion of return pallet places that are not empty pallets in%: 5%	
Dispatched pallet spaces with empty pallets a year:	500
Number of IPG Environmental Pallets needed in the flow:	20,000
Average transportation distance in km:	380

TERMINALS

Number of rented pallet spaces at terminals in square metres:	800
Current rent per square metre of pallet spaces a year:	SEK 600

ECONOMY

Return transport cost per pallet space a year:	SEK 400
Purchasing price IPG Environmental pallet a piece:	SEK 450
Purchasing price IPG Environmental pallet restock a piece:	SEK 450
Deposit refund IPG environmental pallet a piece:	SEK 80
Discards in %:	4.0%
Internal interest in %:	7.0%
Savings rate in %:	1.0%

Would you like to avoid binding up capital and putting a strain on the company's cash flow? Rent your environmental pallets for an immediate 40 per cent ROI!

» [Read more about renting on page 14](#)

DATA

	CALCULATED
Number of dispatched pallets a year:	362,500
Number of pallet movements a year:	18
Number of IPG environmental pallets for restock a year:	800
Transport loading height in cm:	266
Total number of return pallet spaces wooden pallets a year:	19,600
Number of reduced return pallet spaces a year:	6,043

INVESTMENT

Total investment in the IPG environmental pallet:	SEK -9,000,000
---	----------------

SAVINGS

Savings on return pallet spaces a year:	SEK 2,417,000
Repairs to wooden pallets a year:	SEK 667,000
Loss/restocks wooden pallets a year:	SEK 1,133,000
Restocks IPG environmental Pallet a year:	SEK -360,000
Deposit received IPG environmental Pallet a year:	SEK 64,000
Savings on terminal places a year:	SEK 192,000
Total savings a year:	SEK 4,113,000
Total savings a month:	SEK 343,000

ENVIRONMENT

Savings on number of full lorries + trailers a year:	126
Reduction in carbon emissions a year:	51,000

SUMMARY IPG ENVIRONMENTAL PALLET VS EUR WOODEN PALLET

Investment in the IPG Environmental Pallet:	SEK -9,000,000
Number of IPG Environmental Pallets:	20,000
Internal interest in %:	7.0%
ROI number of months	24
ROI number of years	2.0

	Economy	Environment
Number of years	Return on investment	Savings kg CO²
1	SEK -3,690,000	51,000
2	SEK 290,000	102,000
3	SEK 4,430,000	153,000
6	SEK 17,090,000	306,000
8	SEK 25,750,000	408,000
10	SEK 34,580,000	510,000

Based on an actual flow



IP GROUP

THE ENVIRONMENTAL PALLET'S CLOSED-LOOP SYSTEM GIVES RESULTS

The Environmental Pallet did not come about by chance. It has taken a lot of hard work to design a pallet that actually makes a difference, not just for you who handle it, but also commercially and not least environmentally.

The Environmental Pallet is easy to handle, space-saving and a true environmentalist. Its low weight and supreme stackability gives you 40 per cent fewer returns, thus reducing your carbon footprint by 40 per cent!

By introducing a refund deposit system we have taken responsibility for the environment by recycling our products

to 100 per cent and creating a green closed-loop system. We pay back the deposit to our customers when it is time to scrap the product.

A pallet that makes a difference!

- Reduced return transports
- Reduced carbon emissions
- Replaces disposable pallets
- Reduces wasted resources
- Refund deposit system
- 100% recyclable
- 100% reusable





IP GROUP LEAN & GREEN IMPLEMENTATION

Environmental improvement is good business. This will not only lead to possible savings of up to 40 per cent, you will also enjoy some goodwill among employees and partners. IP Group strives to improve companies' strategic environmental and resource efficiency. We are convinced that environment and sustainability will become more and more of a "business licence" with regard to both competitiveness and environmental responsibility from a social perspective.

IP Group offers turnkey solutions comprising of joint learning and development initiatives. The aim is to create

value for our partners. A value that focuses on balance in terms of costs, competitiveness and environmental improvements.

IP Group's concept is built on three levels:

- 1) Workshops
- 2) Courses and trainings
- 3) Lean & Green club





IF YOU WIN, WE WIN. IT IS REALLY THAT SIMPLE.

We considered just about EVERYTHING when developing our WorldStar winning Environmental Pallet. And we wanted everybody to feel like winners. You, us and our environment.

So, not only are the three pallet sizes based on EUR size 1200x800 mm compatible with each other like toy bricks, there are also great savings to be made. On several levels. We are talking about 40 per cent fewer return transports, at least 40 per cent better stackability, 40 per cent reduced weight, 40 per cent reduction in carbon emissions and 100 per cent recycling and reuse.

IPG Intelligent Packaging Group AB

Västrevångleden 2 • SE-302 41 Halmstad • Sweden
Switchboard: +46 35 10 24 80 • Fax: +46 35 12 71 60
Email: info@ip-group.se • www.ip-group.se

IPG Intelligent Packaging Group AS

Hensmoveien 46 • NO-3516 Hønefoss • Norway
Switchboard: +47 38 99 40 13 • Mobile: +47 960 49 556
E-post: info@ip-group.no • www.ip-group.no